



FENPEI MODULAR OUTDOOR SOFA

Vittorio Paradiso

Fenpei arreda gli ambienti con l'audacia di un sistema flessibile composto da moduli che si trasformano in soffici ed accoglienti isole di lusso. Ogni modulo è definito da una cucitura decentrata che determina la scissione della seduta e degli schienali in due sezioni con colori a contrasto. È composto da morbidi elementi, imbottiti in poliuretano a densità differenziata avvolti da una plumette in fiocco di microfibra, che alternano le quattro varianti di seduta e i due schienali disponibili. Gli schienali, zavorrati, possono essere posizionati liberamente, o essere ancorati alle sedute grazie ad un funzionale e raffinato alamaro in bamboo che, agganciandosi ad un laccio in cuoio posto sulla seduta, regola le quattro posizioni dello schienale. Il basamento in metallo per esterno, finitura epossidica Bronze Shadow opaco, sostiene il volume confermando l'incredibile sensazione di leggerezza.

Fenpei furnishes rooms with the boldness of a flexible system composed of modules that transform into soft and welcoming islands of luxury. Each module is defined by an off-center seam that results in the splitting of the seat and seatback into two sections with contrasting colours, thus creating a colour play having strong graphic impact. Is composed by padded elements made of differentiated-density polyurethane wrapped in a microfiber staple plumette that alternate between the four available seat and two seatback variations. The counterweighted backseats can be positioned freely or anchored to the seats thanks to a functional and refined bamboo frog that sets the four seatbacks by hooking onto a leather lace placed on the seat. The outdoor metal base, featuring matt Bronze Shadow epoxy finish, supports the overall volume, thus highlighting once again the incredible feeling of lightness.



MAIN COMPONENT | POUF 1060

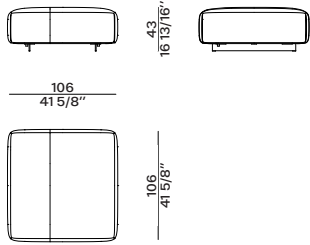

MAIN COMPONENT | POUF 1710

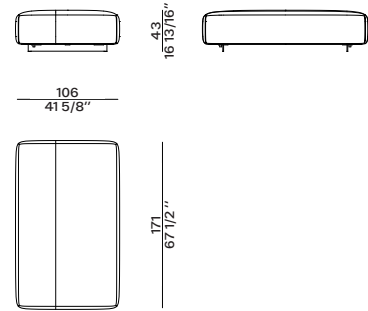

CONNECTION COMPONENT | POUF 650

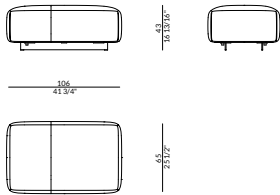

CONNECTION COMPONENT | TRAPEZOIDAL POUF

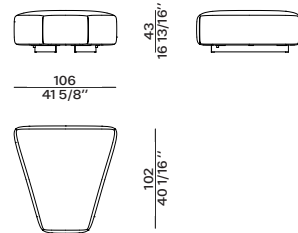

LINEAR BACKREST

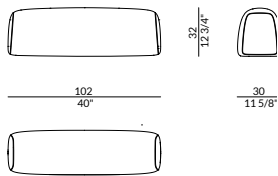

CORNER BACKREST

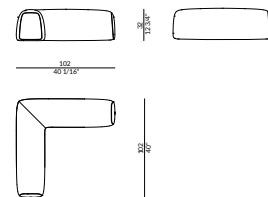

DECORATIVE CUSHIONS | 50X35 CM 70X50 CM

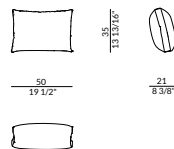
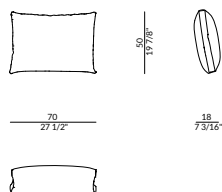



AN EXAMPLE OF POSSIBLE COMPOSITION

FP-001

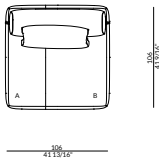

FP-003

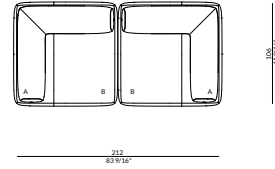

FP-006

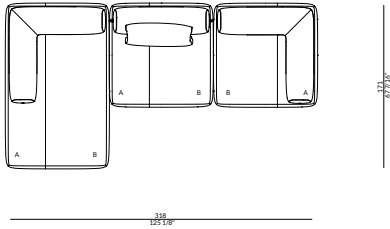

FP-008

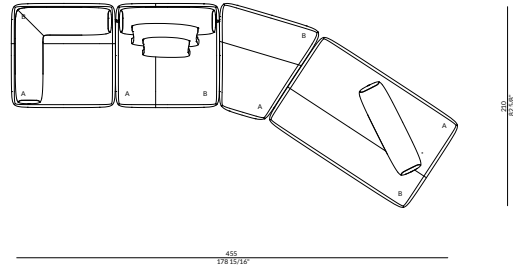

FP-009

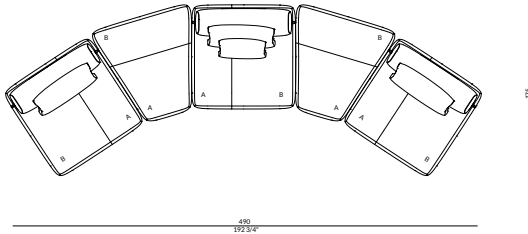

FP-010

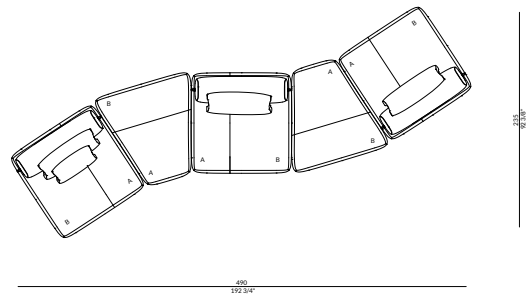

FP-011

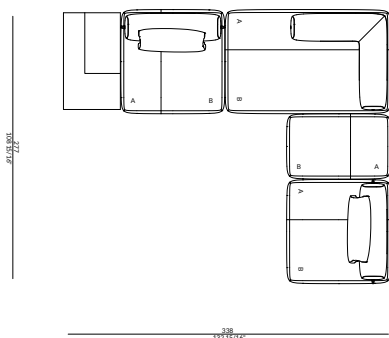

FP-013

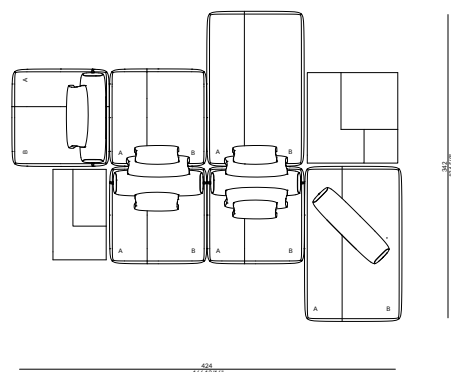



CARATTERISTICHE TECNICHE

Dimensioni

POUF 106 : L. 106X106; H. 43
POUF 171: L. 171X106; H. 43
POUF 65: L. 65X106; H. 43
POUF TRAPEZIO: L. 102X106; H. 43 CM
SCHIENALE LINEARE: L. 102; P. 30; H. 32
SCHIENALE ANGOLARE: L. 102X102; P. 30; H. 32

Dimensioni espresse in centimetri. L'azienda si riserva il diritto di apportare modifiche ai modelli senza preavviso. Le informazioni sono basate sugli ultimi dati pubblicati a listino.

Peso

POUF 106: 21,5 KG
POUF 171: 29 KG
POUF 65: 16 KG
POUF TRAPEZIO: 18 KG
SCHIENALE LINEARE: 11,5 KG
SCHIENALE ANGOLARE: 20,5 KG

Materiali

- Struttura: Metallo, Multistrato marino
- Rivestimento: Tessuti outdoor

Finiture

- Struttura: Bronzo shadow opaco
- Rivestimento: Tessuti cat. Outdoor
Per i rivestimenti, fare riferimento alla Sample Chart.

ISTRUZIONI PER L'USO E LA MANUTENZIONE

Utilizzare il prodotto nel rispetto delle corrette destinazioni d'uso.

Pulitura di macchie e sporco

Metallo: Pulire con un panno morbido in microfibra leggermente umido. Asciugare completamente per evitare la formazione di ossidazione.

Tessuto Outdoor: Aspirare regolarmente per rimuovere la sporcizia come polvere e briciole. Lavare con acqua tiepida e un detergente delicato. Evitare l'uso di candeggina o detersivi aggressivi che potrebbero danneggiare il tessuto.

ECOLOGIA

Il prodotto, i suoi componenti e gli involucri di imballo/protezione non vanno dispersi nell'ambiente al termine del loro utilizzo, ma conferiti ai sistemi di smaltimento autorizzati, in conformità alle normative vigenti in materia.

TECHNICAL FEATURES

Dimensions

POUF 106: L. 106X106; H. 43
POUF 171: L. 171X106; H. 43
POUF 65: L. 65X106; H. 43
TRAPEZOIDAL POUF: L. 102X106; H. 43
LINEAR BACKREST: L. 102; P. 30; H. 32
ANGULAR BACKREST: L. 102X102; P. 30; H. 32

Dimensions are expressed in centimeters. The company reserves the right to make changes to the models without prior notice. The information is based on the latest data published in the catalog.

Peso

POUF 106: 21,5 KG
POUF 171: 29 KG
POUF 65: 16 KG
TRAPEZOIDAL POUF: 18 KG
LINEAR BACKREST: 11,5 KG
ANGULAR BACKREST: 20,5 KG

Materials

- Structure: Metal, Marine Ply
- Upholstery: Outdoor fabrics

Finishes

- Structure: Bronze shadow matt finish
- Upholstery: Fabrics cat. Outdoor
For upholstery, refer to the Sample Chart.

INSTRUCTIONS FOR USE AND MAINTENANCE

Use the product in accordance with the correct uses.

Cleaning of stains and soiling

Metal: Clean with a damp soft microfiber cloth. Dry completely to prevent oxidation.

Outdoor Fabric: Vacuum regularly to remove dirt such as dust and crumbs. Wash with lukewarm water and a mild detergent. Avoid using bleach or aggressive detergents that could damage the fabric.

WASTE DISPOSAL

The product, its components and the packaging/wrapping should not be dumped at the end of use but instead sent to authorised disposal sites, in accordance with current laws on this subject.



MATERIALI E FINITURE

I colori stampati sono da considerarsi puramente indicativi.
Per i rivestimenti, fare riferimento alla [Sample Chart](#).

MATERIALS AND FINISHES

Printed colors are to be considered as purely indicative.
For upholstery, refer to the [Sample Chart](#).



METAL FINISH
Bronze Shadow matt



Paolo Castelli S.p.A. si riserva il diritto di apportare miglioramenti tecnologici ed estetici ai propri modelli, comprese le modifiche alle dimensioni e ai materiali, senza preavviso. I disegni tecnici non definiscono i dettagli del prodotto. Le misure mostrate sono indicative e potrebbero subire modifiche. Per informazioni specifiche, si prega di contattare il rivenditore più vicino a voi.

Paolo Castelli S.p.A. reserves the right to make technological and aesthetic improvements to its models, including changes to the sizes and materials, without notice. The technical drawings do not define the details of the product. The measurements shown are indicative and may undergo changes. For the specific information, please contact the dealer closest to you.

I prodotti Paolo Castelli S.p.A. vengono elaborati interamente a mano, finiti uno per uno, da abili artigiani italiani. Ciò garantisce l'originalità del prodotto e la sua esclusività. I meccanismi interni, le tessiture e i materiali possono subire piccole variazioni che offrono ad ogni prodotto una sua unica personalità.

Paolo Castelli S.p.A. products are manufactured by Italian experienced handcraftsmen, finished one by one. The entire mechanism, the textures and materials may have small variations giving every product a unique personality.

